

How to Install and Operate No.3656 STOCK CAR OUTFIT

FOR "027" and "O" GAUGE TRACK

What Is Included In the Outfit

Check these items:

1 a stock car



2 a stockyard corral with loading ramp

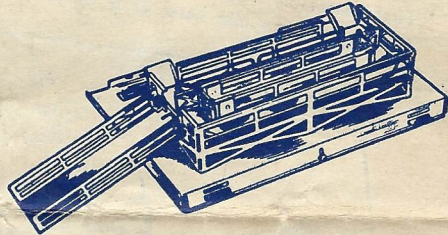

3 nine head of cattle, boxed

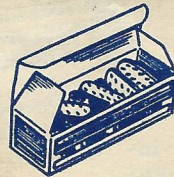

4 a 364C controller



5 three coiled, insulated connecting wires



6 a track lockon



7 set of conversion parts for "O" gauge track



ground clip



power blade



How to Install Corral Platform In the Layout

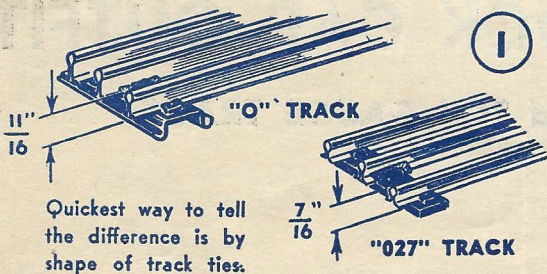

Important!

This platform comes assembled for ".027" track. If your track is ".027" continue reading. If your track is "O", first read page 7.

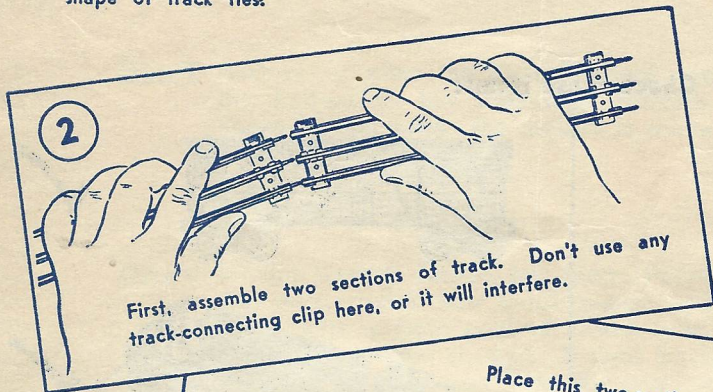

The platform can be installed along any straight portion of track at least two sections in length.

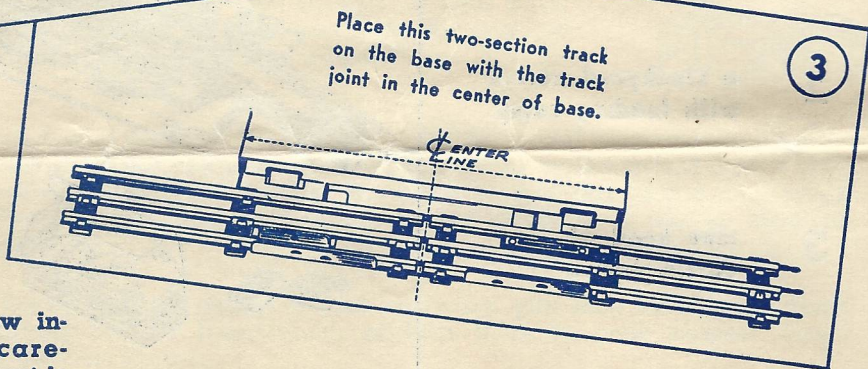

NOW, follow instructions carefully. This part is important.

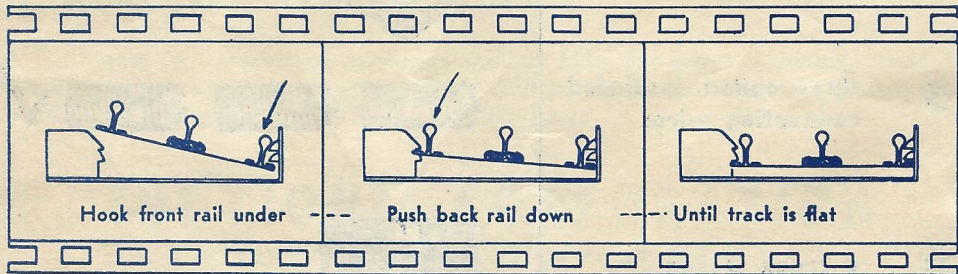

The track in the picture is ".027" and fits under the bottom notches. The top notches are for "O" gauge track which is higher (See Fig. 1).

Make sure the rails fit under all four corresponding notches or the car will be tilted and will not operate properly.

**Here's the easiest way to do this job!
use both hands — do one side at a time**

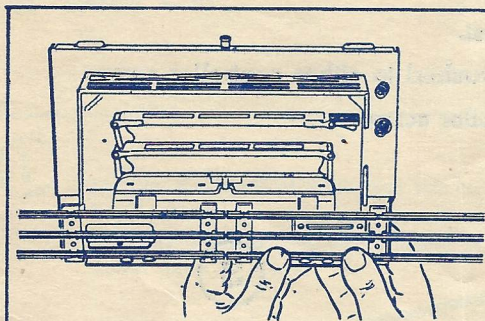

Hook front rail under circular notches — top notches for "O" gauge, bottom for "027" track—

5

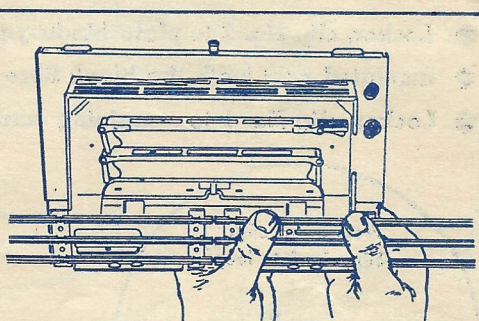

—then snap in back rail under the corresponding back notches squeezing the track slightly.

6

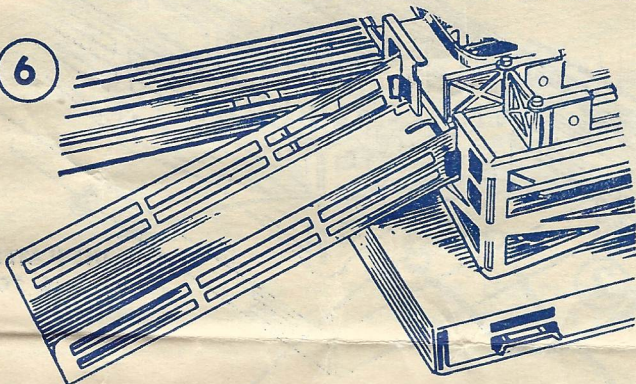

After the two-section track and the platform are assembled together, fit them to the rest of your layout and put on the cattle loading ramp.

How to Make Electrical Connections

First, snap the lockon onto the track next to your corral platform.

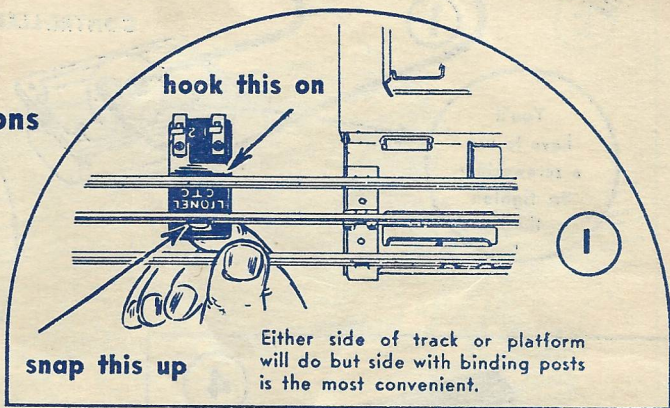

Either side of track or platform will do but side with binding posts is the most convenient.

DON'T FORGET TO CLEAN OFF THE INSULATION FROM THE ENDS OF THE WIRES.



Trick here is not to "cut" the wire. Wrap the wire around your index finger. Rest the wire on a solid surface. Place dull knife edge firmly on the wire. Pull the wire toward you.

Continued on Next Page

These are the wire connections

- Lockon clip No. 2 to plain binding post.
- Insulated post (with the black fibre washer) to either controller screw.
- Lockon clip No. 1 to remaining controller screw.

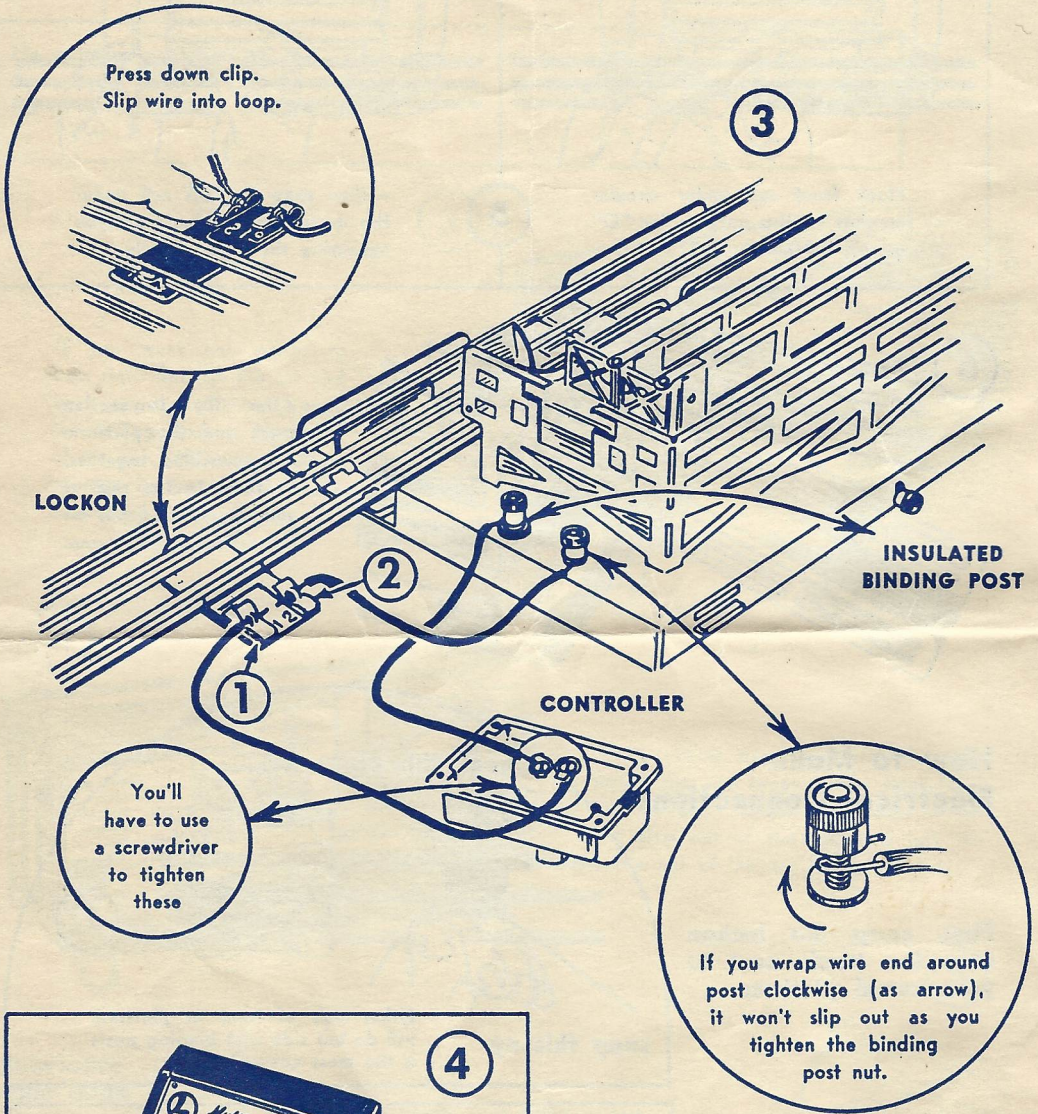

Connected in this way the car and the platform get the same voltage as the train. To raise or lower the voltage to obtain better action move the transformer voltage control handle.

How to Operate The Stock Car

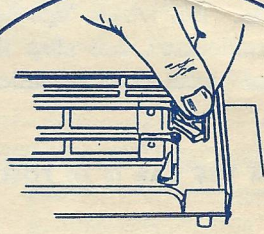

1

Line up five head of cattle (all the car will hold) with their heads away from the ramp. Use any passage you wish. Open proper corral gates by hand.

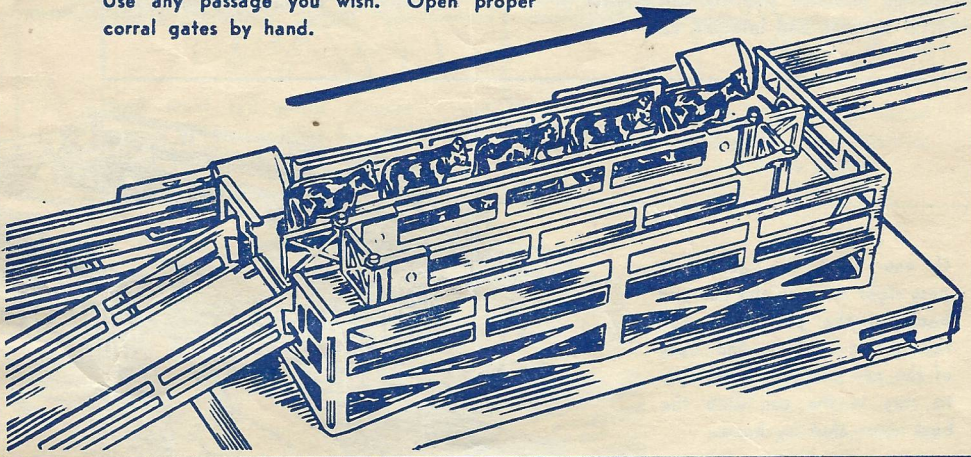

LINE UP THE CAR IN FRONT OF THE PLATFORM ACCURATELY. THE OVERHEAD DOORS MUST LINE UP WITH THE EDGES OF THE PLATFORM.

2

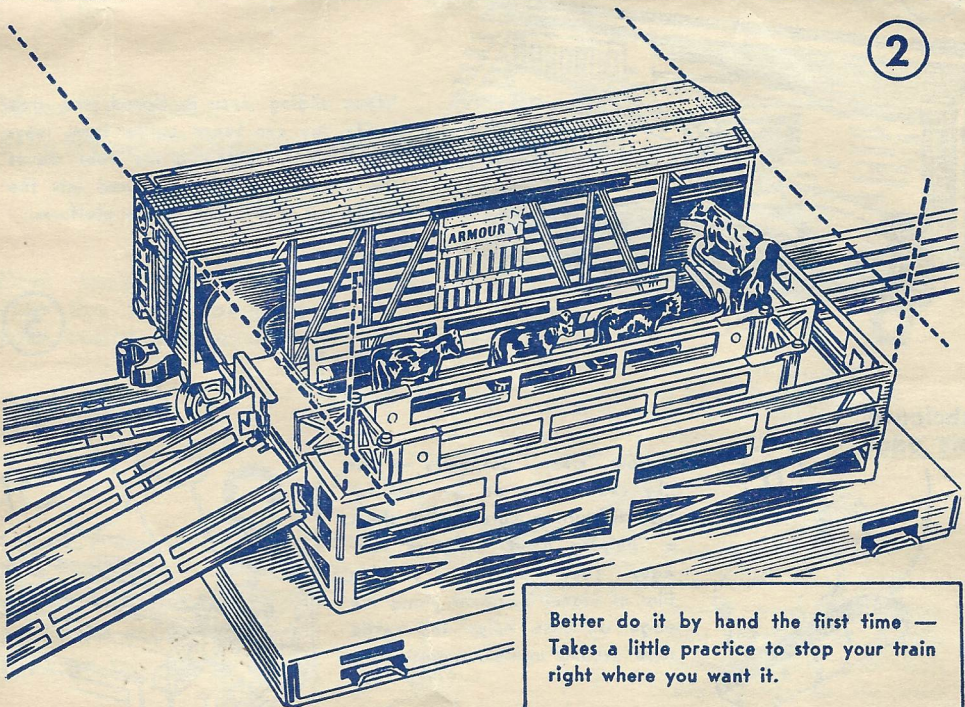

Better do it by hand the first time — Takes a little practice to stop your train right where you want it.

Continue on next page. →

Your Stock Car and Corral Platform work on the same voltage as the train. So, when "spotting" the car at the platform don't turn off the transformer, but stop the train by putting the locomotive into "neutral" with the "Direction" control on your transformer.

AFTER THE CAR IS IN POSITION SLIDE THE CONTROLLER SWITCH:

The overhead car doors will rise. Platform ramps will drop to meet the car and the vibrations of the platform and the cattle track in the car will send the cattle trooping along the corral passage and into the car.

If you want the cattle to pass right through the car and back on the platform, open the sliding door in the back of the car. If you want them to stay in the car slide the back door shut by hand.

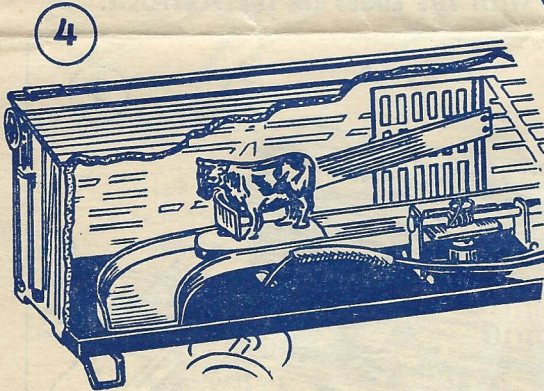
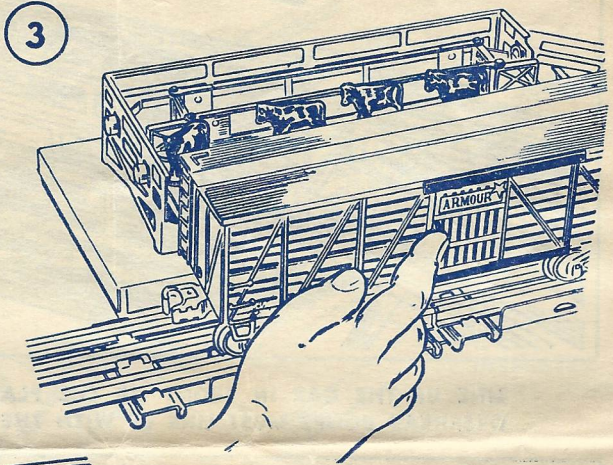

When sliding door is closed, the stop inside the car keeps cattle from leaving the car. Opening the door moves the stop out of the way and lets the cattle out of the car to the platform.

**lubricate
this edge**



If your "steers" get balky — just like real cattle do — and refuse to turn a corner give them a "helping hand" or raise voltage. (See Page 4.) A thin film of Lionel lubricant along the edge of base helps the cattle slide around corners more easily.

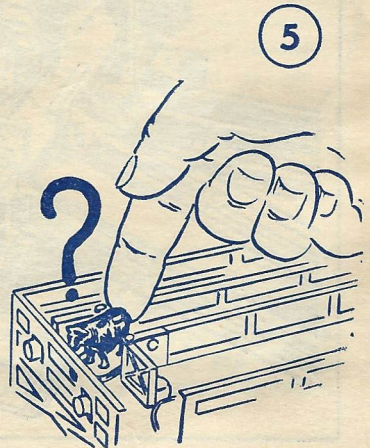

How to Set Up Platform For "O" Gauge Track

If your track is "O" Gauge, make the following changes before assembling the platform to the track:

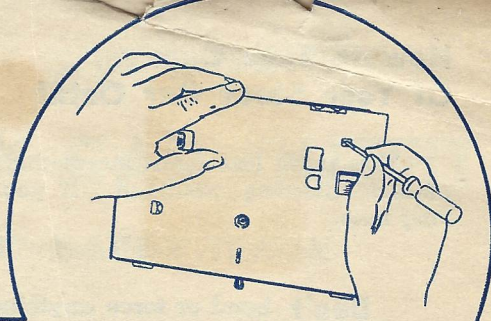

REMOVE "027" POWER BLADE (If it's tight push it out through hole in platform with a screwdriver, etc.)

Change the height of contacts

1 CLIP ON GROUND CONTACT

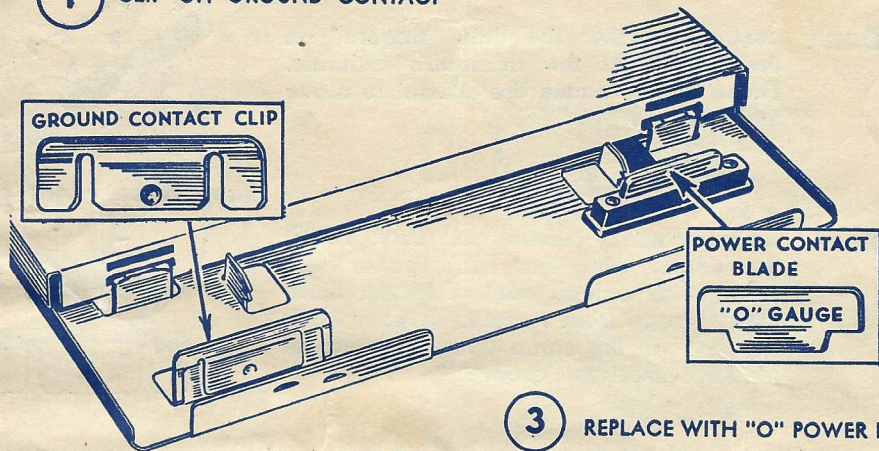

3 REPLACE WITH "O" POWER BLADE

Change the height of platform

Take off knurled nut in the back. Slide platform off the metal guides and slide it back on so that the guides fit into BOTTOM slots — front and back. Then replace nut.

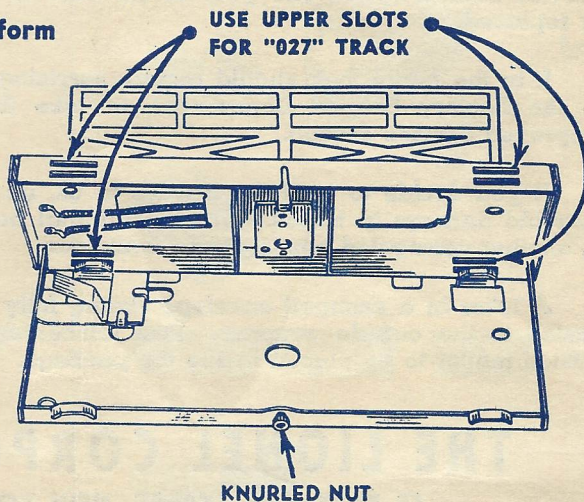

4

The base and the platform are spread apart in the drawing only to show the construction. You can keep them flat or spread them just a little.

Now go back to page 2

How to Take Care Of Your Stock Car Outfit

This outfit has been thoroughly tested at the Factory and should be in perfect operating condition. If you give it a little care it will last you a long time.

Don't bend or force anything. If you distort the platform or the base they may not work properly.

Don't destroy or alter the little "fingers" on the bottom of the miniature animals. These fingers cause the animal to move and turn.



Don't let the contact blades get rusty. Polish the edges with fine sand paper and cover with a light coat of Lionel lubricant to keep from rusting. If your track is "027" do the same thing for edge of platform used as "ground."

keep these edges clean



Like all Lionel products the stock car and the corral platform are guaranteed against defective materials and workmanship to the extent that if any such defective article is returned to the Factory or to any Lionel Authorized Service Station within one year of the date of purchase it will be repaired or replaced.

If in the future they should require servicing, you may either send them to the Factory Service Department, or take them to your nearest Lionel Approved Service Station.

If you decide to mail the articles to us, be sure to pack them carefully to avoid damage in transit. Use the original boxes if possible, and enclose in another corrugated box or strong container.

A letter in a stamped envelope stating fully the service desired must be pasted to the outside wrapper. Post Office regulations do not permit any written matter to be placed inside the package.

THE LIONEL CORPORATION

15 EAST 26th STREET, NEW YORK 10, N. Y.

Service Department
28 Sager Place
Irvington, N. J.

Chicago Showrooms
Merchandise Mart
Chicago, Ill.

APPROVED SERVICE STATIONS IN THE PRINCIPAL CITIES, UNITED STATES AND CANADA

Printed in U. S. of America

Form No. 3656-43-5-54-TT